

LW-R-06 A/0

(P3)FR SOCKET

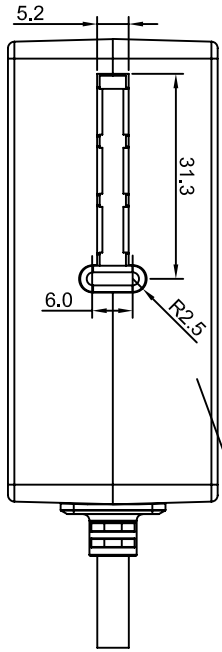

REVISIONS				
ZONE	REV	DESCRIPTION	DATE	APPROVED
A		RELEASE	2011.03.02	Gary
B		修正尺寸	2011.03.28	Gary

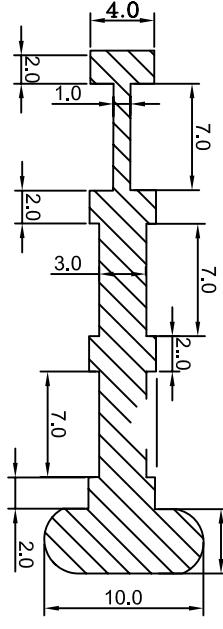

WHITE MARKING ARIAL 10號

3000±50

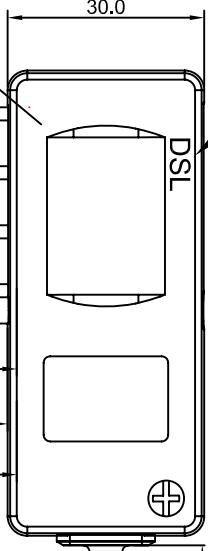

(P2)FR PLUG

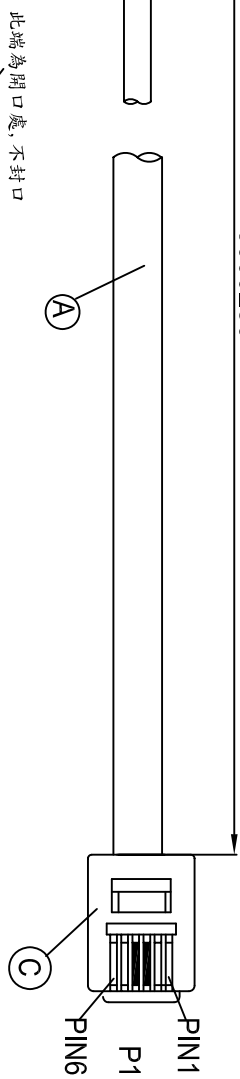
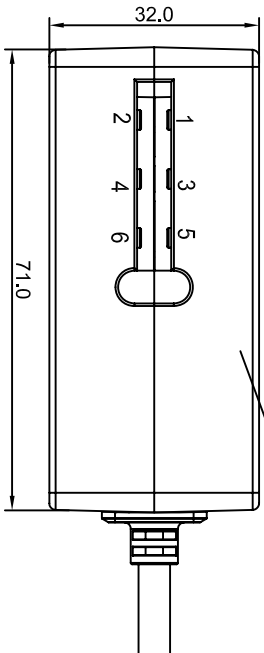

此端為開口處，不封口

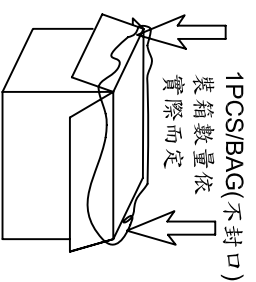
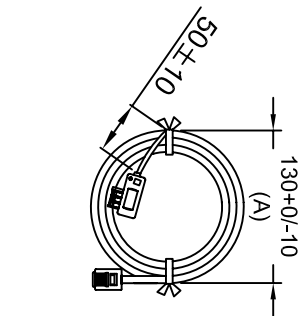
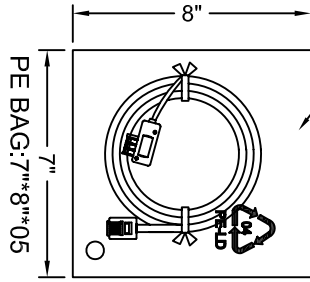

NOTE:FR SOCKET&PLUG All the pin have iron

ITEM NO	ITEM	DESCRIPTION	VENDER	UNIT	QTY
C	PLUG	US PLUG 6P2C 3U" (GREEN PART)		PCS	1
B	PLUG	FR PLUG & SOCKET ABS 94V-2 BLACK(GREEN PART)		PCS	1
A	CABLE	FLAT CABLE 2C 28AWG 7/0.12 PVC+PP NO-UL OD:2.4*4.8±0.2MM BLACK (GREEN PART)		PCS	1

General Tolerance		Customer Code		601	
DIMENSION:		Drawing No	M12235	TLE TUNG-LL, E200633	
X	±1	Publish NO.	B	Customer P.N.	
X.X	±0.5	Sheet:	1 OF 4	Model No.	SL040-3
X.XX	±0.2	Title:	SL040BC621N0M/3M-3		
Cable length:±2% ANGLE:±5°		Approve By	Inspected By	Checked By	Drawn By
					Ruby
		Date	2011.03.28		
		SCALE:	NONE		
		Units:	mm		

8	7	6	5	4	3	2	1
---	---	---	---	---	---	---	---