

ZONE	REV	DESCRIPTION	DATE	APPROVED
✓	A	RELEASE	2008.08.07	ANN

LW-R-06 A/3

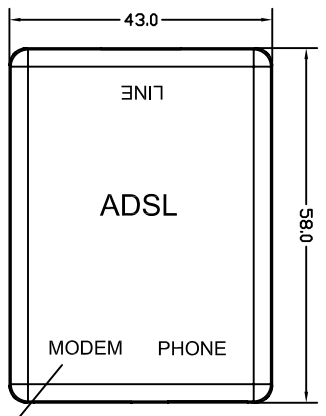

MARKING BLACK TEXT  
MODEL NO. GB046

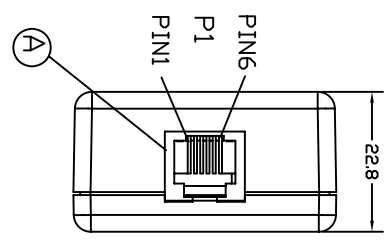
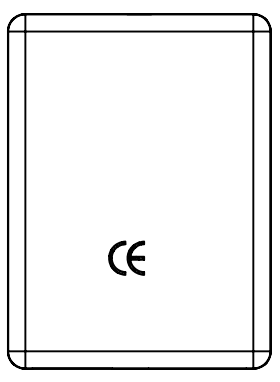
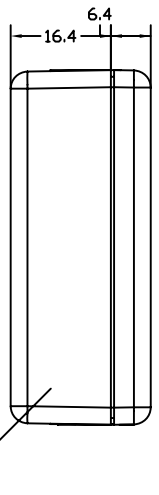
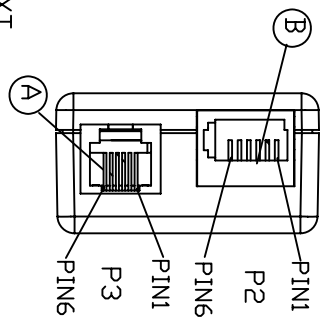

ITEM NO	ITEM	DESCRIPTION	UNIT	QTY
C	PLASTIC	ABS 94V-2 WHITE (GREEN PART)	PCS	1
B	JACK	UK JACK 6P4C 3U" 94V-2 (GREEN PART)	PCS	1
A	JACK	US JACK 6P2C 3U" 94V-2 (GREEN PART)	PCS	2

General Tolerance		Customer Code	
DIMENSION:		621	
X	±1	DRAWING NO.	M6640
X.X	±0.5	Publish NO.	A
X.XX	±0.2	SHEET:	1 OF 1
Cable length: ±2%		TITLE:	SL060WXXXP1NXV/A
ANGLE: ±5°		APPROVE BY	
		CHECKED BY	
		DRAWN BY	CLUBS
		DATE	2008.08.07
		SCALE:	NONE
		UNITS:	mm

**TLE TUNG-LI, ISO-9001**  
**E200633**

8 7 6 5 4 3 2 1

LW-R-06 A/3

REVISIONS		
ZONE	REV	DATE
	A	08-07-15
		RELEASE

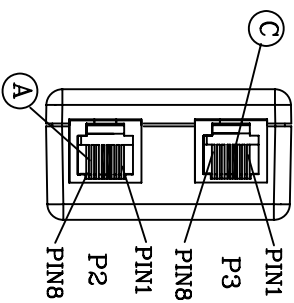
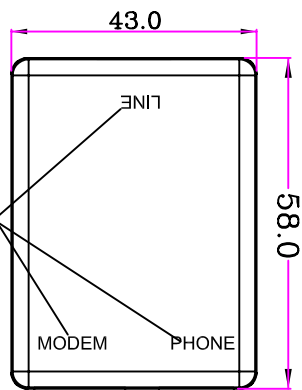
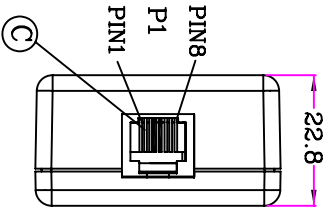

WHITE MARKING GB064

1PCS/BAG  
50PCS/BAG  
裝箱數量依  
實際而定

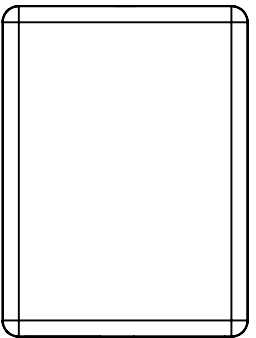
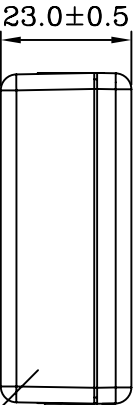
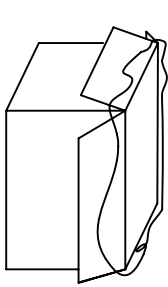

ITEM NO	ITEM	DESCRIPTION	VENDER	UNIT	QTY
C	WIRE GOLD	18MM,20.5MM 3U" (GREEN PART)		PCS	12
B	PLASTIC	ABS 94V-2 BLACK (GREEN PART)		PCS	1
A	JACK	US JACK 8P2C 3U" 94V-2 BLACK (GREEN PART)		PCS	3

General Tolerance		Customer Code	
DIMENSION:		661	
X	±1	Drawing No	M9000
X.X	±0.5	Publish NO.	A
X.XX	±0.2	Sheet:	1 OF 1
Cable length: ±2%		Title:	Model No.
ANGLE: ±5°		Approve By	Checked By
		Drawn By	Cindy
		Date	2008.07.15
		SCALE:	NONE
		Units:	mm

**TILE TUNG-LI, ISO-9001 E200633**

Customer P. N. SL060-E  
Model No. SL060BX821LX1/E

Drawn By: Cindy  
Date: 2008.07.15  
SCALE: NONE  
Units: mm

LW-R-06 A/3

REVISIONS		
ZONE	REV	DATE
	A	08-07-15

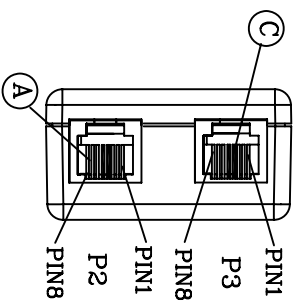
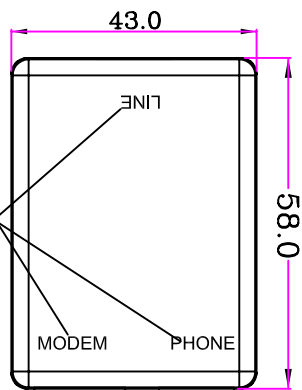
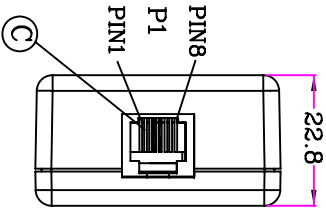

WHITE MARKING GB064

1PCS/BAG  
50PCS/BAG  
裝箱數量依  
實際而定

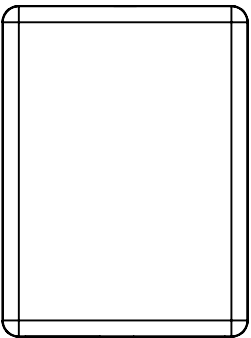
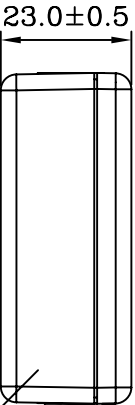
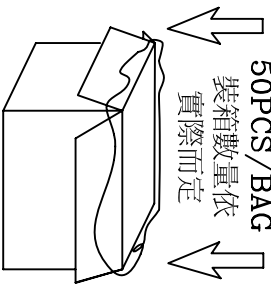

ITEM NO	ITEM	DESCRIPTION	VENDER	UNIT	QTY
C	WIRE GOLD	18MM,20.5MM 3U" (GREEN PART)		PCS	12
B	PLASTIC	ABS 94V-2 BLACK (GREEN PART)		PCS	1
A	JACK	US JACK 8P2C 3U" 94V-2 BLACK (GREEN PART)		PCS	3

  

General Tolerance		Customer Code	
DIMENSION:		661	
X	±1	Drawing No	M9000
X.X	±0.5	Publish NO.	A
X.XX	±0.2	Sheet:	1 OF 1
Cable length: ±2%		Title:	Model No.
ANGLE: ±5°		Approve By	Drawn By
		Checked By	Cindy
		Date	2008.07.15
		SCALE:	NONE
		Units:	mm

**TILE TUNG-LI, ISO-9001 E200633**

SL060-E  
SL060BX821LX1/E

REVISIONS			DATE	APPROVED
1	RELEASE	2008.07.15		
2	RELEASE	2008.07.15		

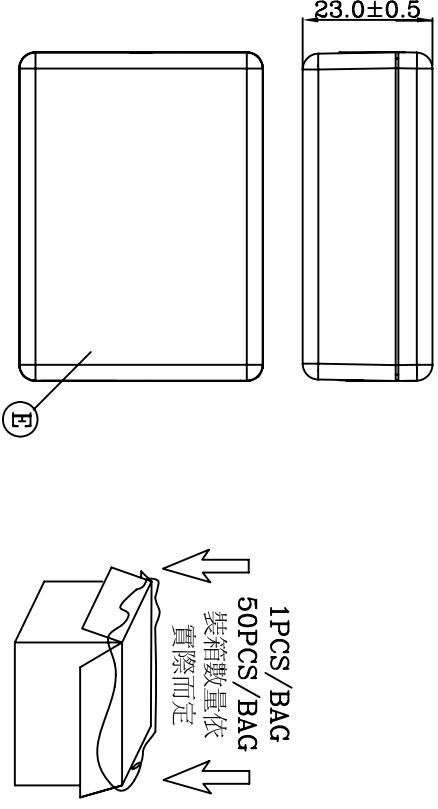
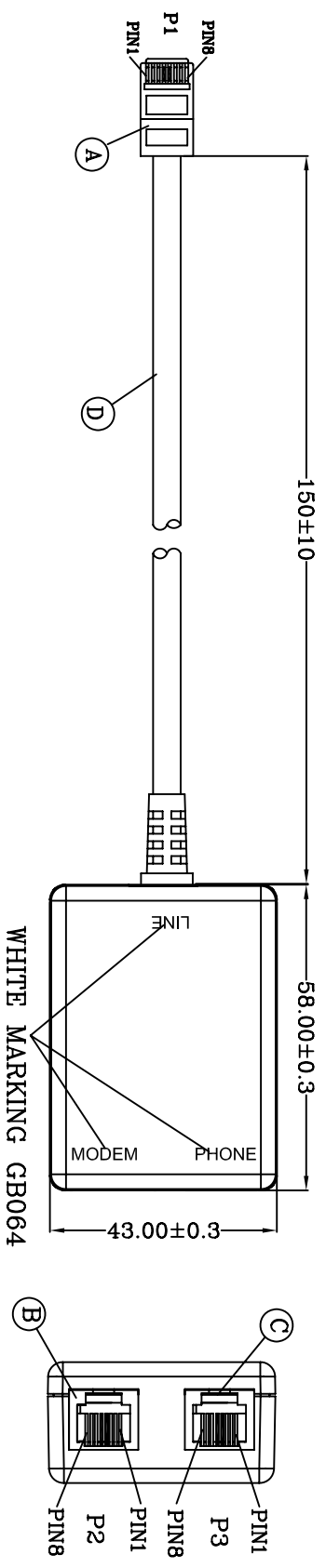

1PCS/BAG  
50PCS/BAG  
裝箱數量依  
實際而定

ITEM NO	ITEM	DESCRIPTION	UNIT	QTY
E	PLASTIC	ABS 94V-2 BLACK (GREEN PART)	PCS	1
D	CABLE	FLAT CABLE UI20251 2C 28AWG 7/012 PVC+PP OD:2.4*4.8±0.2MM BLACK WITH MD SR (GREEN PART)	PCS	1
C	JACK	US JACK 8P2C 3U" 94V-2 WHITE (GREEN PART)	PCS	1
B	JACK	US JACK 8P2C 3U" 94V-2 WHITE (GREEN PART)	PCS	1
A	PLUG	US PLUG 8P2C 3U" (GREEN PART)	PCS	1

General Tolerance		Customer Code		Customer P. N.	
DIMENSION:		DRAWING NO.	661	TLE TUNG-LI, ISO-9001	
X	±1	PUBLISH NO.	M9001	SL060-F	
X X	±0.5	SHEET:	1 OF 1	SL060BC821IX1/F15CM	
X.XX	±0.2	TITLE:	SL060BC821IX1/F15CM	SL060-F	
Cable length: ±2%		APPROVE BY:	Cindy	DATE: 2008.07.15	
ANGLE: ±5°		CHECKED BY:		SCALE: NONE	



SCALE: NONE  
Units: mm